

3.

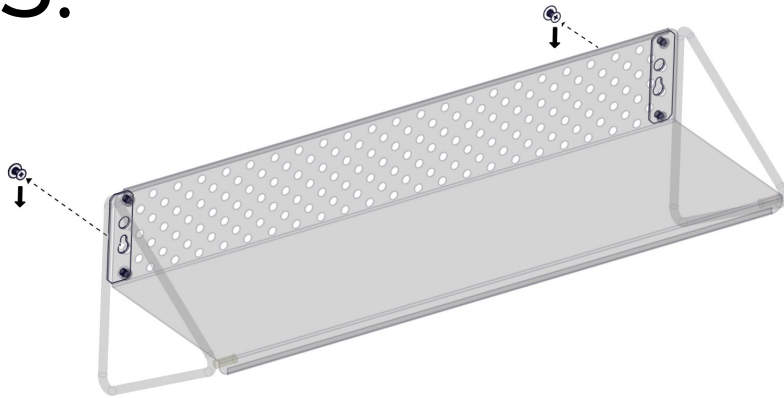

F. Fleysen

MN10124

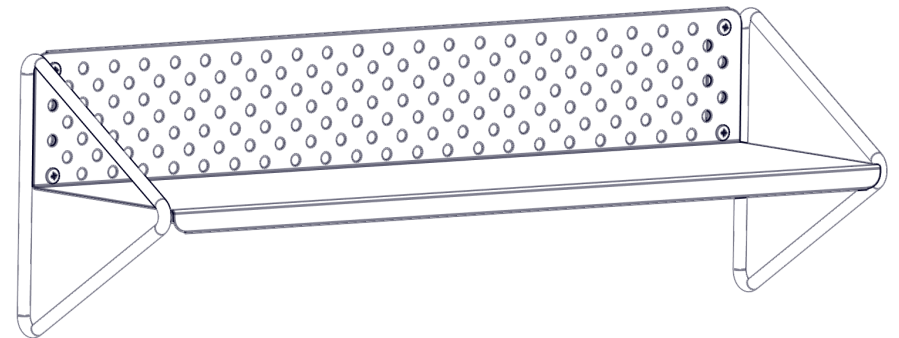

4.

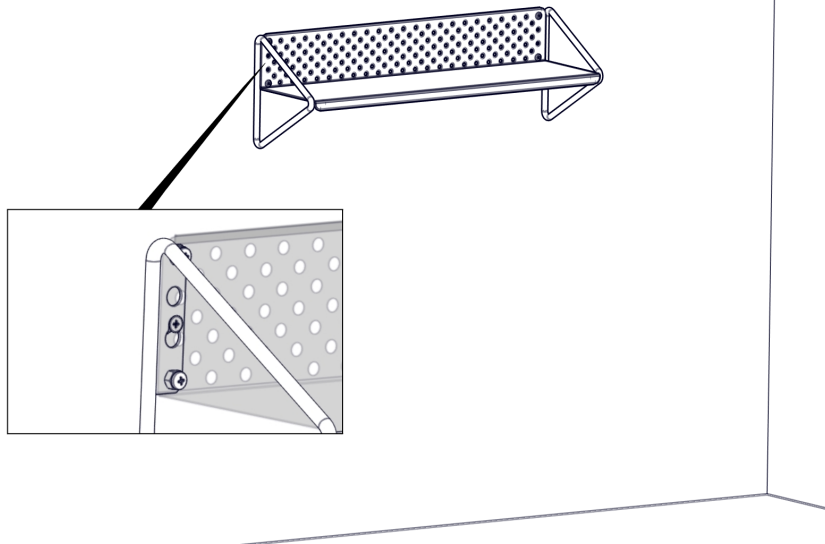

#1713

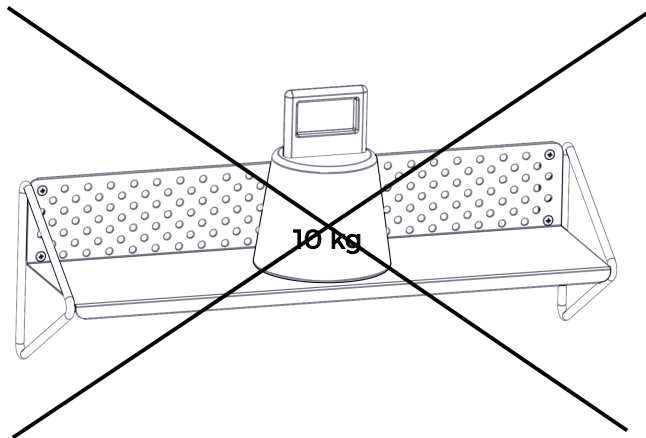

Max. 10 kg

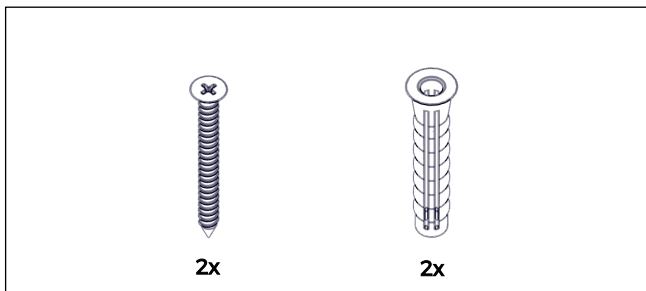
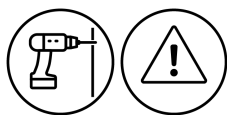
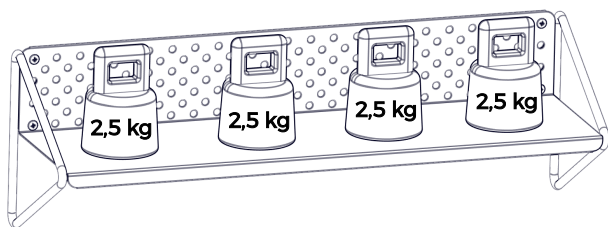

1.

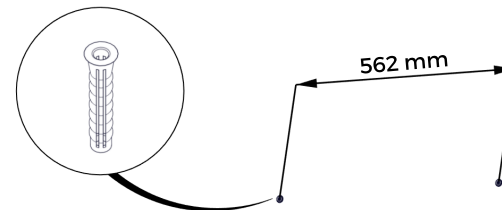

2.

