

F. Fleysen # 1211

MN10093

Česky

Důležité!
Tento nábytek je třeba upevnit ke stěně.
Různé typy stěn vyžadují různé způsoby upevnění.
Použijte takový spojovací materiál, který je vhodný pro vaše stěny. Pokud si nejste s výběrem šroubů a hmoždinek jistí, obraťte se na specializovaného prodejce.

English

Important!
This furniture must be fixed to the wall.
Different wall materials require different types of fixing devices. Use fixing devices suitable for the walls in your home. If you are uncertain about what type of screw or fitting to use, please contact your hardware store.

Deutsch

Achtung!
Dieses Möbelstück muss an der Wand angebracht werden.
Verschiedene Materialien erfordern verschiedene Arten von Befestigungsbeschlägen. Immer Befestigungsmaterial verwenden, das für die häuslichen Wände geeignet ist.
Gfs. sollte man sich beim Eisenwarenfachhandel nach geeignetem Befestigungsmaterial erkundigen.

Français

Attention!
Ce meuble doit être fixé au mur.
Le choix des vis dépend du matériau dans lequel elles doivent être fixées. Utiliser des vis adaptées au matériau de votre mur. En cas de doute, demander conseil à un vendeur spécialisé.

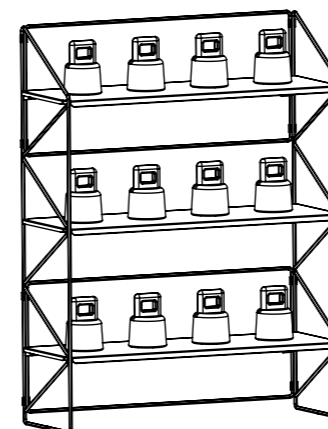
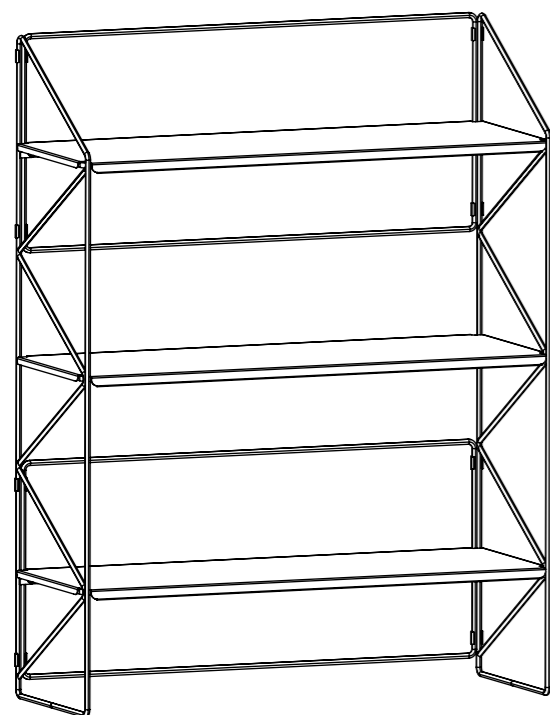

MAX 20 kg

MAX 20 kg

MAX 20 kg

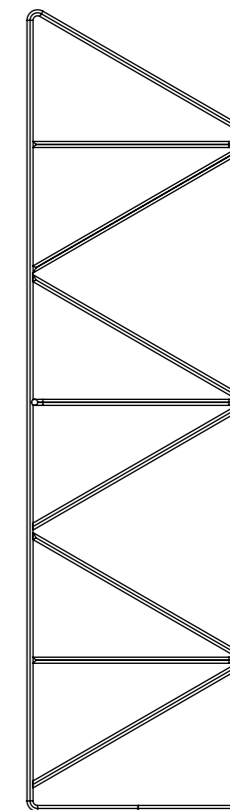
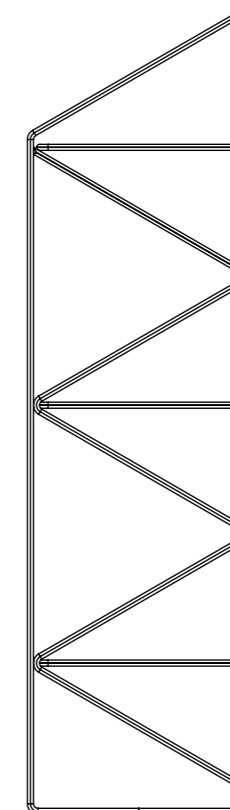
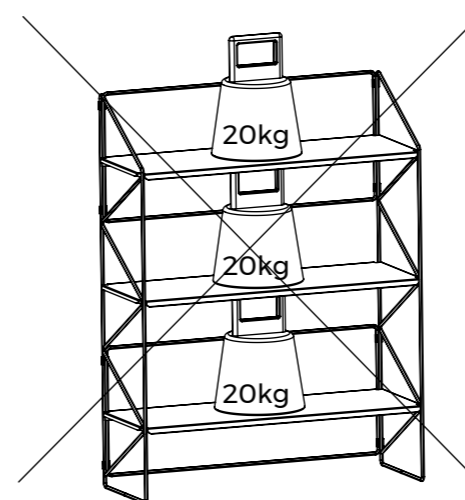

1 x

1 x



4 x

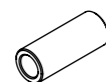

4 x



4 x

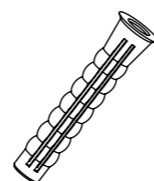

4 x

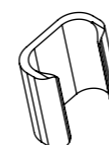

8 x

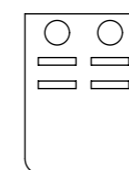

4 x

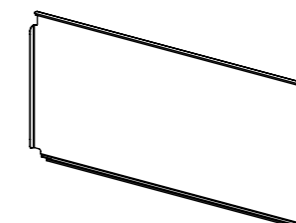

3 x

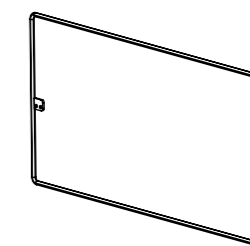

2 x

F. Fleysen

