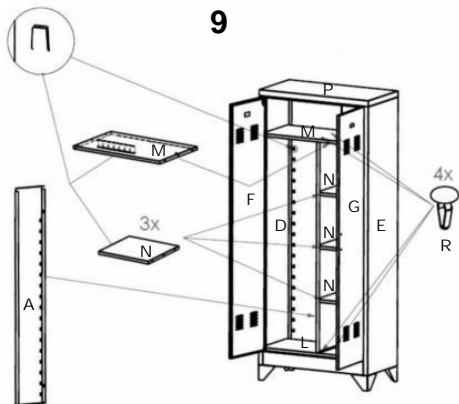

9**10**